

GalcoGunleather.com
Facebook.com/galcoGUNleather.com
Twitter.com/galcoGUNleather.com
YouTube.com/galcoGUNleather
Instagram.com/galcoGUNleather
Pinterest.com/galcoGUNleather



Galco Customer Service can be reached
Toll Free at 800-874-2526
or by Email at:
customerservice@galcoGUNleather.com



PRODUCT INFORMATION GUIDE POCKET HOLSTERS & ACCESSORIES

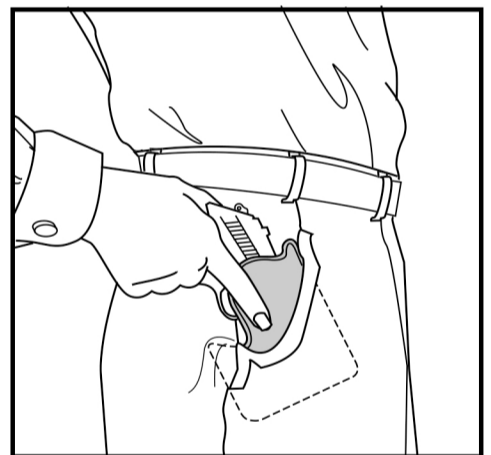

GalcoGunleather.com
2019 West Quail Avenue Phoenix Arizona 85027

SAFETY SYMBOL DEFINITIONS



Indicates a hazardous situation which, if not avoided, will result in death or serious injury.



Indicates a hazardous situation which, if not avoided, could result in death or serious injury.



Indicates a hazardous situation which, if not avoided, could result in minor or moderate injury.



Used to address practices unrelated to potential personal injury.



Visit GalcoGunleather.com/videos to view related safety videos.

IMPORTANT SAFETY WARNINGS AND INSTRUCTIONS READ PRIOR TO USING GALCO PRODUCTS



Firearms users must understand and obey the Rules of Firearms Safety:

1. All firearms are always loaded.
2. Never let the muzzle cover anything you're not willing to destroy.
3. Keep your finger off the trigger until your sights are on target.
4. Be sure of your target and what's beyond.

WARNING Failure to heed these warnings or follow the operating instructions may result in negligent discharge of a firearm, causing serious injury or death.

Read and understand all owner's manuals, instructions, and guides prepared by the manufacturer of your firearm prior to use.

Galco holsters are designed to carry specific firearms.

WARNING Before use, be sure the holster selected is designed and intended to carry your particular firearm.

If you have any questions about correct fit, contact Galco Customer Service at 800-874-2526 or customerservice@galcoGUNleather.com. You may also visit GalcoGunleather.com and use our online fitting guide.

WARNING Carrying a firearm in an ill-fitting or improper holster can result in serious injury or death. The purchase and use of a Galco holster is at the sole and exclusive risk of the user.

READ AND UNDERSTAND THIS ENTIRE GUIDE PRIOR TO USING THIS PRODUCT

Firearms are inherently dangerous. Improper or careless use of a firearm or firearm and holster may result in serious injury or death. It is the user's responsibility to possess a thorough knowledge of, and be properly trained in, all aspects of firearm use, including holster use and safety.

WARNING Do not place a loaded firearm in a holster without first testing – with a firearm double-checked and verified to be unloaded – for a proper firearm fit.

CAUTION Tension units are not pre-set at the factory. If a holster has tension units, it is the user's responsibility to ensure they are appropriately adjusted to appropriately retain the firearm.

Carry the firearm in the safe condition recommended by its manufacturer. This information will be contained in the product information manual provided by the firearm manufacturer. If you do not have the manual applicable to the firearm, contact the firearm's manufacturer.

Always ensure the firearm is fully seated in the holster, and that it activates all automatic or manual retention devices (when provided). Retention devices must be used when provided.

WARNING If the firearm is not properly secured by means of friction or the retention device(s), it could become dislodged, causing injury and possibly death to the user and others.

WARNING Never holster a firearm in the single-action mode, unless it is a semi-automatic pistol and holster designed and intended for "cocked and locked" or "Condition One" carry.

WARNING Always ensure that a single-action pistol carried in "Condition One" has the manual safety engaged when carrying in a holster.

WARNING Do not attempt to cock a holstered firearm as this may damage the firearm, the holster, or both, and may contribute to a negligent discharge.

CAUTION Always protect an exposed magazine release from accidental activation.

WARNING When drawing a firearm or replacing it in the holster, DO NOT place your finger on the trigger, in the trigger guard, or near the trigger. Position your finger along the frame of the firearm above the trigger guard. Keep your finger off the trigger until your sights are on target.

WARNING When placing the firearm into the holster, always ensure clothing, jacket drawstrings or other foreign objects have not fallen into the holster or become trapped while holstering the firearm. Foreign objects entering the trigger guard may depress the trigger, causing the firearm to discharge.

NOTICE When placing the firearm into the holster, always place your thumb over the hammer or behind the slide. This will enable you to feel if the hammer starts to move rearward, or the slide begins to come out of battery.

WARNING If a firearm falls out of its holster, it may fire, causing death or serious injury.

Always place your hand on the firearm and holster when running or performing other physically vigorous activities.

It is the user's responsibility to maintain the holster by regularly checking component parts for excessive wear and proper function. This includes, but is not limited to, tension units, snap closures and retention devices.

Checking tension units each time the holster is used is required as part of your regular safety inspection.

Applying a small amount of clear nail polish to the threads of the tension units, after proper adjustment, will help minimize screw loosening.

WARNING Do not use customized, modified, worn or broken firearms, or those otherwise outside the original manufacturer's specifications, in a Galco holster.

Do not in any way modify, disassemble, or remove any part from this holster, except as approved and recommended in Galco's Product Information Guide.

Do not rely on any holster being "snatch proof" regardless of the number of retention devices it may feature. Rely only on proper training and situational awareness.

NOTICE Do not expose your holster to extreme heat, such as the interior of a car in summer, or leave it otherwise exposed to the elements.

CARRY CONDITION OF THE FIREARM

WARNING Some single-action revolvers and some semi-automatic pistols must be carried with the hammer or firing pin resting on an empty chamber.

Carrying any firearm with a live cartridge in the chamber immediately in front of the firing pin may cause a negligent discharge. Information regarding the safe carry condition of your firearm will be contained in the product information manual provided by the firearm's manufacturer. If you are unsure of the safe carry condition(s) of your firearm, contact the firearm's manufacturer.

IF ANY DOUBT EXISTS AS TO THE SERVICEABILITY OR SAFETY OF A GALCO PRODUCT, IMMEDIATELY CEASE USING IT

**If you have questions, contact:
Galco Customer Service at 800-874-2526
or customerservice@galcoGUNleather.com.**

Galco has made every effort to properly label all holsters for the specific firearms they fit. However, firearms manufacturers often make changes to their firearms that affect holster fit.

Galco will not be responsible for such changes, nor for typographical or other human errors that may occur. It is the user's responsibility to ensure proper holster fit with actual firearms.

It is important to understand that all products, including firearms and holsters, may eventually "wear out" or become unsuitable for the function for which they were designed. Stress and strain placed on a product will vary according to frequency and conditions of use, and therefore it is difficult to indicate a recommended replacement date for this product.

INSPECTIONS / MAINTENANCE, ADDITIONAL USER RESPONSIBILITIES

WARNING It is the user's responsibility to ensure that the item remains serviceable and safe, and able to continue service within its design intent.

NOTICE It is the user's responsibility to inspect the holster before and after each use for signs of excessive wear or loss of retention capability, and appropriate tightness of all hardware.

PRODUCT IDENTIFICATION

Galco products are generally identified with a two-part code stamped into the holster body or label affixed to the item.

An alphabetical or alphanumeric prefix identifies the holster model. For example, the FLETCH model's prefix is FL while the Royal Guard's prefix is RG.

The numerical suffix identifies the particular firearm the holster is intended to fit. For example, the 212 suffix indicates a 5" 1911 while the 224 suffix indicates a Glock 17. The letter "B" or "H" at the end of the code indicates color. B is for black, H for havana brown, while no letter generally indicates tan.

Thus, an FL212 (FL + 212 + no letter) will be a tan FLETCH to fit a 5" 1911, while an RG224B (RG + 224 + B) will be a black Royal Guard for a Glock 17.

Holsters intended for Galco's modular shoulder systems display letters and numbers that correspond to guns. A Miami Classic holster intended for a SIG P320, for example, will simply read 820. A VHS holster intended for a Beretta 92FS will read V202.

The numerical suffix of holsters intended for right-hand or ambidextrous use will end in an even number. The suffix of holsters intended for left-hand use will end in an odd number.

You may use the search field found at our website, GalcoGunleather.com, to locate a holster fit. Simply enter the model number on the item (FL224B, for example) in the field. Should you have questions regarding the identification of the firearm intended for your Galco product, you may also contact Galco's customer service department at 800-874-2526 (during business hours) or by email at customerservice@galcoGUNleather.

WARNING A small number of Galco holsters are approved for use with multiple firearms. Care must always be taken to ensure your holster is an appropriate and approved fit for your firearm. Never carry a firearm in any holster not specifically recommended by Galco for that firearm.

THANK YOU FOR YOUR PURCHASE OF A GALCO PRODUCT! WE APPRECIATE YOUR BUSINESS.

POCKET HOLSTERS

While limiting the carrier to a relatively small handgun, pocket carry offers some unique advantages. Not only is the handgun completely covered and concealed, but the gun carrier can casually place a hand on the holstered/pocketed pistol if a nonspecific threat materializes – and the fastest draw is to have the gun already in hand.

Galco's pocket holsters keeps the firearm or spare magazine in the same general position so you can quickly locate the grip when you need to draw. It also conceals the shape of the gun so that its outline is not printed through the garment.

▲ WARNING

Always remove the holster from the pocket before holstering the handgun!

FRONT POCKET HORSEHIDE HOLSTER

Galco's Front Pocket™ horsehide holster is constructed from premium horsehide and is designed for front pocket carry in pants or a jacket.

The holster allows one-handed release of the gun from both the pocket and the holster. The holster accomplishes this by hooking and catching on one of two leather hooks on the holster into your top or bottom pocket corner when you draw your firearm. With practice (using an unloaded firearm) you can draw the firearm while the holster remains in your pocket or falls away.

POCKET PROTECTOR HOLSTER

Galco's Pocket Protector™ is constructed of Premium Center Cut Steerhide™. Reinforcements at the holster mouth and beneath the trigger guard keep the holster stiff enough to allow a smooth draw, while also maintaining enough rigidity to prevent “printing” and shifting of the handgun.

The holsters hooked shape – at the base of the handgun's trigger guard – is designed to catch on the pocket so that, with practice (using an unloaded firearm) and while using the proper pants of jacket, you can draw the firearm while the holster remains in your pocket or falls away.

POCKET MAGAZINE CARRIER

The Pocket Magazine Carrier (PMC™) is constructed from Premium Center Cut Steerhide and carries a single spare magazine in the off-side pocket. The PMC features an adjustable tension unit for a customizable draw. The hooked shape is designed to catch on the corner of your pocket and retain the carrier in pocket on the draw.

DO

▲ WARNING

Keep your finger off the trigger until your sights are on the target!!



NOTICE

Ensure that all screws are tightened snugly. Applying a small amount of clear nail polish to the threads will minimize screw back out.

Full grain leather holsters that come in contact with bodily perspiration, the elements, or become soiled on a regular basis may need to be treated periodically to slow the natural breakdown of the leather fibers. Dry the leather naturally, without any type of artificial heat. Use Galco Leather Lotion, which will replace the natural oils in the leather.

DON'T

▲ WARNING

Do not place a loaded firearm in a holster without first testing – with a firearm double-checked and verified to be unloaded – for proper firearm fit.

NOTICE

Do not store your firearm in a holster if the holster is damp from perspiration or in otherwise moist condition.

Do not use LocTite® or threadlock. Out-gassing from these adhesive compounds will adversely affect plastic, nylon and rubber holster parts.

Do not submerge or saturate your leather product in water or any other liquid or dry your leather product with heat from a dryer, oven, radiator, direct sunlight, etc.

Do not use products such as Neats Foot or Mink oil, as they will damage the leather. Additionally, do not use Galco Leather Lotion or other leather conditioners on Premium Center Cut Steerhide.

Do not leave your Galco product on the dashboard of your car in summer, or leave it otherwise exposed to the elements.

NOTICE

The above care and maintenance instructions cannot substitute for your good common sense. Following our recommended care and maintenance tips, along with common sense, will allow you to get the maximum service life from your Galco products.

HOLSTER FIT / BREAK-IN

Galco's full grain leather holsters are made of the finest materials and are precision molded to specific firearms. It may appear the holster fit is too tight at first, but this is by design. We engineer our holsters to fit tightly knowing the leather fibers will relax to the proper fit with use.

▲ WARNING

UNLOAD YOUR FIREARM (chamber, magazine, cylinder) before testing holster fit.

If the holster has tension screws: Tension units are not pre-set at the factory. You may need to adjust them in order to holster your handgun the first time. We recommend that you check your tension screw adjustments before each use. There is no reason to completely remove tension units. Do not use LocTite® on tension units. However, a single drop of clear nail polish applied to your tension screw threads may reduce its unwanted loosening.

If the fit is too tight when holstering your firearm the first time don't force it. If you do force the firearm into the holster, it may be very difficult to remove. Instead, follow these simple steps to break in your new holster using a process called blocking:

- 1 Place the unloaded firearm in a plastic freezer bag, or cover it in 2-3 layers of plastic kitchen wrap. Do not cover the grip.
- 2 Insert the bagged/wrapped firearm slowly into the holster, gently twisting it side-to-side to minimize tearing of the bag/wrap.
- 3 Once the firearm is completely seated in the holster, twist it approximately 1/16" in both directions 6-12 times.
- 4 Allow the bagged/wrapped firearm to sit in the holster for approximately 15 minutes.
- 5 Remove the firearm from the holster and remove the bag/wrap from the firearm.
- 6 Insert the unloaded firearm into the holster, which should now be snug but not loose. If it is still too tight, repeat the above steps until the holster is broken in to your satisfaction.

Following and repeating the above instructions is the only way to an ideal break-in and long service life with proper fit that will last many years.

HOLSTER FIT / BREAK-IN (continued)

It is common for the inside of a leather holster to scratch from a single holstering (called etching). A smooth leather lined holster will be even more subject to this normal occurrence. After this initial etching, the holster will custom fit your firearm.

Some modern pistols have very sharp edges, particularly surrounding the ejection port. This may cause an initial feeling of “dragging” on the draw, but will normally resolve quickly with just a few draw-and-holster repetitions.

Try our Draw-Ez™ applied to the inside of your leather holster to shorten the break-in period and provide a slicker draw. Draw-Ez only treats the interior surface of the leather and will not be absorbed by the leather or harm the finish. Do not use Draw-EZ on Premium Center Cut Steerhide.

FRONT POCKET HORSEHIDE DRAW

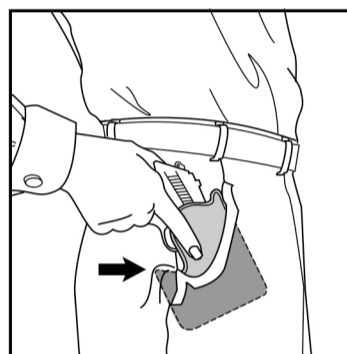
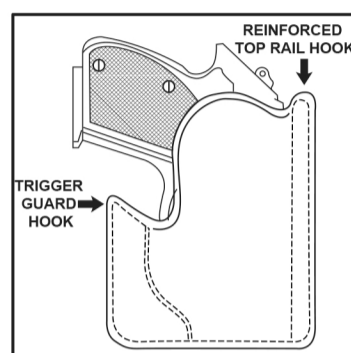

Technique I
Hooking the trigger guard hook on the bottom of the pocket while drawing.

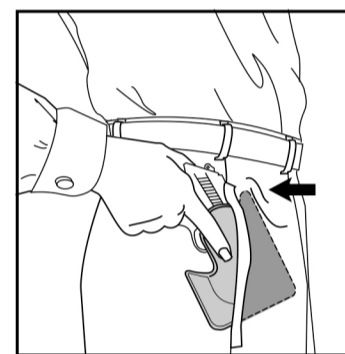

Technique II
Hooking the reinforced top rail hook on the top of the pocket while drawing.

POCKET PROTECTOR DRAW

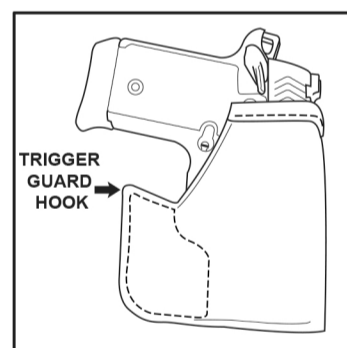

Hook the trigger guard hook on the bottom of the pocket while drawing.

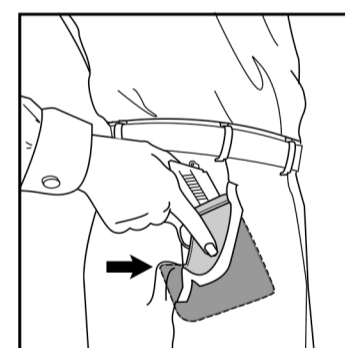

POCKET MAGAZINE CARRIER DRAW

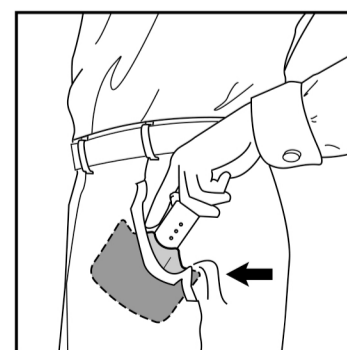
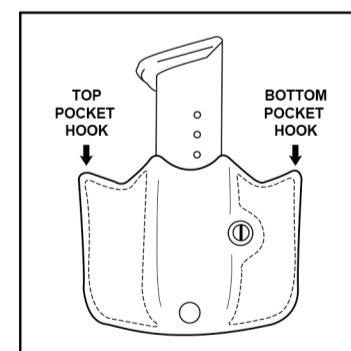

Technique I
Hooking the bottom pocket hook on the bottom of the pocket while drawing.

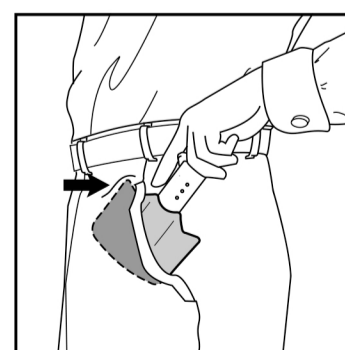

Technique II
Hooking the top pocket hook on the top of the pocket while drawing.

REPAIRS

Great care was taken to select the finest materials available to craft your Galco product. It was designed in accordance with the highest engineering standards and hand made using traditional leather craft practices that have become Galco hallmarks over five decades. In the unlikely event a repair is necessary to an unaltered Galco product, simply contact our Customer Service department at 800-874-2526 or customerservice@galcofirearm.com. We will issue you a Return Authorization (RA) number to print on the outside of your shipping container and provide you with detailed shipping instructions.

NOTICE

CARE, MAINTENANCE AND STORAGE

Dirt and grit trapped in your holster may harm your firearm's finish. To clean your holster, especially after use in dusty conditions, simply wipe out the interior of the holster using a clean, damp cloth.

TERMS OF SALE

Because we have no control over the use of our products, all Galco products are sold as is and “with all faults”. The entire risk as to the quality and performance of the product is with the buyer. Should the product prove defective following its purchase, the buyer and not the manufacturer, distributor, or retailer assumes the entire risk of all the necessary servicing or repairs. Under no circumstances shall Galco be liable for incidental or consequential damages, such as loss of use of property, commercial loss and loss of earnings or profits. The implied warranties of merchantability and fitness for a particular purpose and all other warranties, expressed or implied, are excluded from this transaction and shall not apply to the product sold. The determination of the fitness or the suitability of any product for a specific use is the responsibility of the buyer. The illustrations shown herein are typical as to the finish and application. Due to uncontrollable variances in color saturation, the actual product may differ slightly from that shown on our web site. Galco reserves the right to make changes in product built and/or sold by them at any time without incurring any obligation to make same or similar changes on products previously manufactured and/or sold by them. All Galco products are made in the U.S.A. and produced according to rigid specifications. Prices and models are subject to change without notice. Some states do not allow the exclusion or limitation of implied warranties or liability for incidental or consequential damages, so the above limitations and exclusions may not apply to you. Galco designs, features, and model names are the exclusive property of Galco International. Any and all persons including, but not limited to, individuals, firms and/or corporations are forbidden from imitating, copying or reproducing them in any way.